

# Molteni & C

## PASS-WORD EVOLUTION — DANTE BONUCCELLI 2014 / 2019

1—  
16



Pass-Word, the living-room system designed for contemporary homes, is evolving radically to meet new ways of using domestic spaces, marked by the growing presence of multimedia entertainment systems and/or Home Working, alongside the more traditional objects such as books and ornaments. Storage units are moving towards less minimalist forms, with rounded edges for wing or tip-up doors and wood or lacquered drawers, all with flush metal handles.

The classic cedarwood scented interior is joined by a new melamine finish, Batik in slate grey and ecru, designed to be functional and low maintenance. A new vertical open unit has been added to the system to create open spaces alternating with those closed by doors or drawers. Marble, wood or lacquered tops and newly designed metal feet complete the system. A thick top fitted with built-in wiring compartments, designed to conceal all the wires and connections, can be used both as a support for the TV and/or for media equipment or as a writing surface for a Home Office system.

The tops can be fitted with a concealed LED lighting system designed to diffuse indirect light in the surrounding space. The intensity can be regulated with a remote control. Vertical Stopsol H 120-finish glass storage units, complete with 4 glass shelves lit by concealed LEDs, designed for displaying favourite or precious objects, accessible via a wing door with push&pull opening. Lastly, a system of slim metal shelves in the standard system finishes, hooked to a modulo 35 wooden panel, with which to create bookcases suspended at various heights above the storage units.

### DATASHEET

REGISTERED  
DESIGN

IX.2020

## FINISHES

The drawer interior (sides and bottom) are faced in Batik melamine, or cedar wood (specify when ordering).

\* The doors and front pieces of drawers, matt and glossy lacquer colours, always have a handle in the same finish as the panel (pewter / copper / zinc metal handles, applicable on request without extra charge).

For wooden front pieces, on the other hand, a metal handle is available (pewter, copper and zinc), or a wooden handle.

finishes	Batik melamine	cedar	matt lacquer colours	woods	glossy lacquer colours	pewter colour / copper / zinc	lacquered matt anthracite	extra clear glass	transparent stopsol glass	etched glass	marble	black chrome	lacquered silver
<b>Floor standing bases / storage units / sideboards</b>													
internal structure / drawer interior													
open compartment													
*wooden doors (hinged/flap/flush sliding)				*									
*wooden drawer fronts				*									
plinth													
metal base													
feet													
beam													
coverings											only upper		
partitions													
front drawer interior													
<b>Grado° Bookshelf</b>													
tops													
structure													
back													
<b>Support shelf</b>													
shelf													
rise with wire passage													
wall panel													
undertop track													
<b>Shelf with back</b>													
shelves / side cover													
back													
<b>Hanging display cabinet</b>													
base / top / back													
side / door / shelves profiles													
door / side glass													
<b>Hi-Tech bench</b>													
top													
structure													
feet													

### colours

**Batik melamine**  
XE ecru  
XA slate

**Matt lacquer**  
BC chalk white  
PE pearl  
DN dune  
PL platinum  
NE black  
AT anthracite  
SE mustard  
SI silica  
DO dolomite grey  
AL clay  
MK moka  
CZ light blue grey  
SA sand  
RU ruby  
PX pewter colour  
RX copper  
TO dove grey  
PR petroleum blue  
BG burgundy

**Glossy lacquer**  
BC chalk white  
PE pearl  
DN dune  
PL platinum  
NE black  
AT anthracite  
SE mustard  
SI silica  
DO dolomite grey  
AL clay  
MK moka  
CZ light blue grey  
SA sand  
RU ruby  
PX pewter colour  
RX copper  
TO dove grey  
PR petroleum blue  
BG burgundy

**Woods**  
EU eucalyptus  
RF graphite oak  
NO walnut

**Marble**  
calacatta gold (special price)  
black marquina  
orient grey  
green alpine  
white Carrara

### DATASHEET

REGISTERED  
DESIGN

IX.2020

## TECHNICAL INFORMATION

### STORAGE UNITS

#### UNIT FRAME, INTERNAL PARTITIONS

Chipboard panel covered in melamine facing or covered in Cedar wood (Cedrus) veneer or melamine facing painted in Molteni range colours.

#### OPEN COMPARTMENT

Medium density MDF panel covered in Eucalyptus (Eucalyptus globulus), Oak (Quercus) or Walnut (Juglans nigra) wood veneer or with melamine facing painted in Molteni range colours.

#### DOORS, DRAWER FRONT, COVERING STORAGE UNIT

Chipboard panel covered in veneer from Eucalyptus wood (Eucalyptus globulus), Oak (Quercus), Walnut (Juglans nigra), or melamine facing painted in Molteni range colours.

#### MARBLE UPPER COVERING

Marble in Range finishes with anti-stain, water-repellent treatments.

#### PLINTH

Chipboard panel with melamine facing. With adjustable plastic feet.

#### BASE WITH FEET

Painted tubular metal with die-cast aluminium feet, chromed or painted. With adjustable plastic levellers.

#### HANDLE

In extruded aluminium, painted or covered with Eucalyptus, Oak or Walnut wood veneer.

#### INTERNAL GLASS PARTITIONS

Tempered transparent extra-clear glass, 8 mm thick.

#### DRAWER BOTTOM AND INTERIOR

Chipboard panel covered with Cedar wood veneer.

### BOOKSHELF

#### PERIMETER STRUCTURE

Anodised extruded aluminium joined with metal brackets.

#### GLASS SHELVES

Etched tempered glass, 4mm thick.

#### BACK PANEL

Composite panel of MDF and sheet aluminium (1 mm thick), covered with Oak, Walnut, Eucalyptus veneer or painted in colours from the Molteni Range.

### HI-TECH BENCH

#### STRUCTURE

Anodised extruded aluminium joined with metal brackets.

#### FEET

In die-cast aluminium, chromed or painted, with plastic ferrules.

#### BENCH TOP

MDF panel covered with covered with Eucalyptus, Oak, Walnut veneer or melamine facing, painted in Molteni range colours.

### SHELF WITH BACK PANEL

#### BACK PANEL

Chipboard panel covered in Eucalyptus (Eucalyptus globulus), Oak (Quercus) or Walnut (Juglans nigra) wood veneer or with melamine facing painted in Molteni range colours. Metallic brackets for wall support.

#### SHELF AND PERIMETER PROFILE

In painted extruded aluminium.

### SUPPORT SHELF

#### TOP

Chipboard panel covered in Eucalyptus (Eucalyptus globulus), Oak (Quercus) or Walnut (Juglans nigra) wood veneer or with melamine facing painted in Molteni range colours.

#### WALL PANEL

Chipboard panel covered with melamine facing painted. Metallic brackets for top supports.

#### RISE, UNDERTOP CHANNEL

In painted extruded aluminium.

### DISPLAY UNIT

#### BASE, COVER AND BACK PANEL

Chipboard panel covered with melamine facing painted. Metallic brackets behind back panel for wall mount.

#### DOORS, SIDE PANELS AND SHELVES

In painted extruded aluminium with metallic connecting squares. Extra clear or Stopsol tempered glass, 4 mm thick.

## DATASHEET

REGISTERED  
DESIGN

IX.2020

**TECHNICAL INFORMATION**

STORAGE UNITS

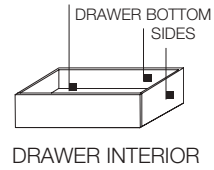
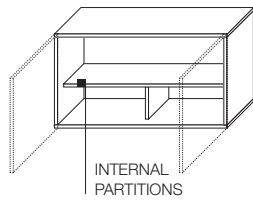
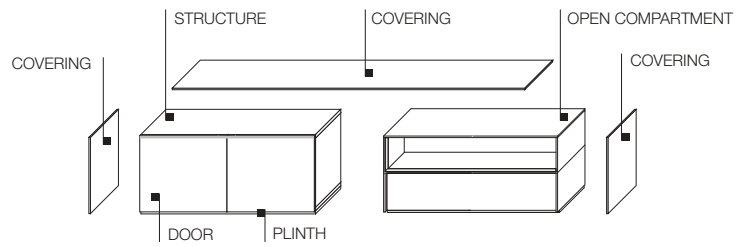
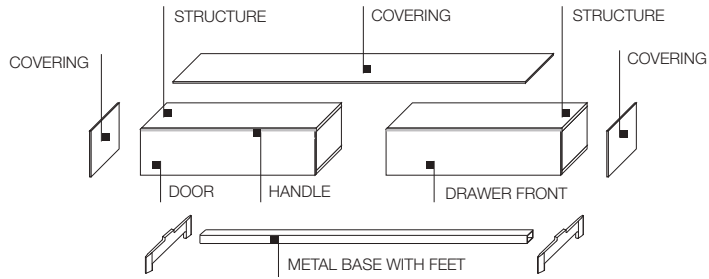

BOOKSHELF

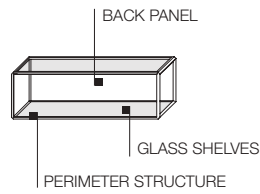

SHELF WITH BACK PANEL

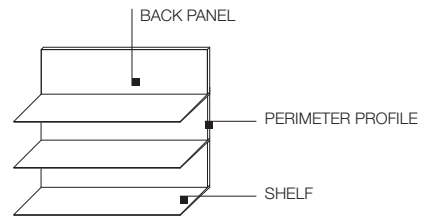

SUPPORT SHELF

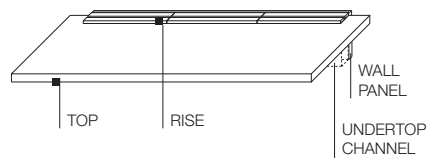

DISPLAY UNIT

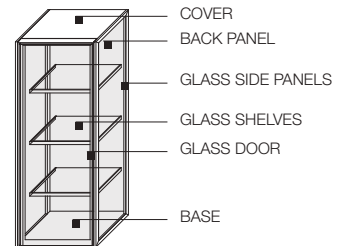

HI-TECH BENCH

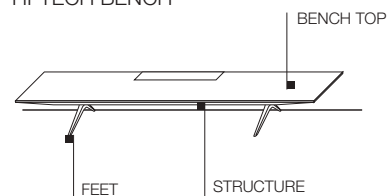

Molteni & C

4—  
16

**DATASHEET**

REGISTERED  
DESIGN

IX.2020

## TYPES / DIMENSIONS

### Sample compositions

All elements are independent and modular.

# Molteni & C

5—  
16

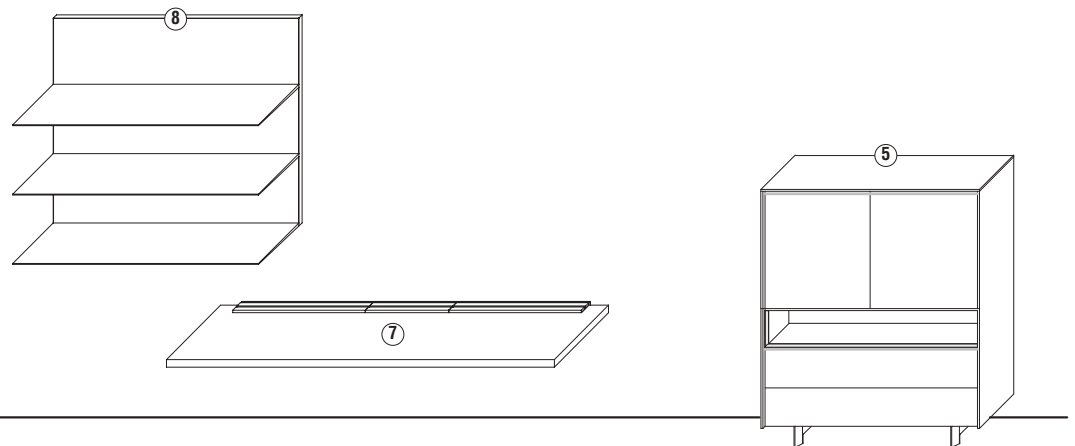
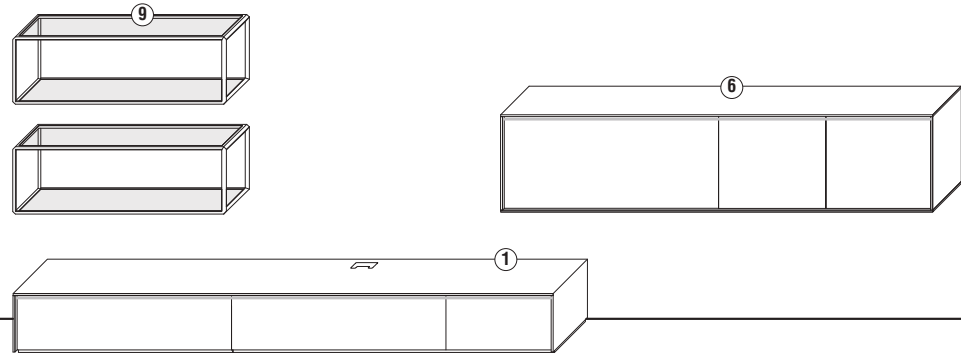
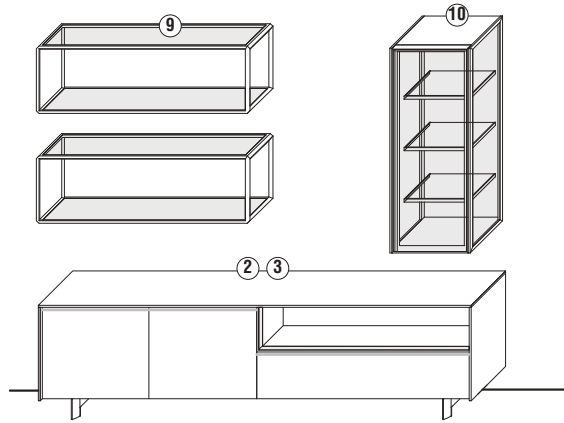

### DATASHEET

REGISTERED  
DESIGN

IX.2020

## TYPES / DIMENSIONS

### Presentation

- ① Floor standing bases H 320 (12 5/8") D 495 (19 1/2") - with plinth

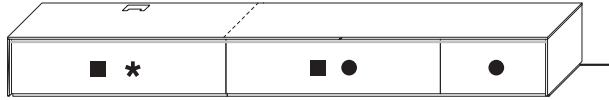

- Floor standing bases H 450 (17 3/4") D 495 (19 1/2") - with metal base

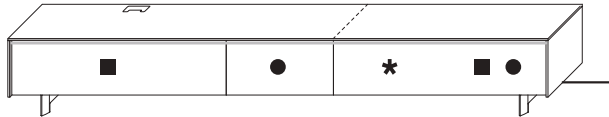

#### Legend

- = Flap door
  - = Drawers
  - ▲ = Hinged door
  - ◆ = Flush sliding door
  - \* = Open compartment W 940/1100
- (the W 235/275 open compartments cannot be used as end units)

Molteni & C

6—  
16

- ② Floor standing storage units H 510 (20") D 495 (19 1/2") - with plinth

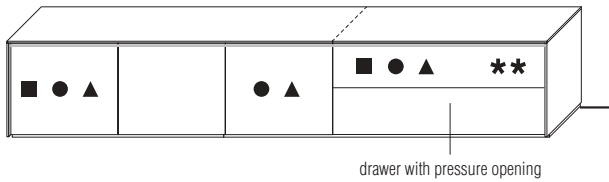

drawer with pressure opening

- \*\* Module with open compartment and drawer W 940 (37") / 1100 (43 1/4")



drawer with pressure opening

- Floor standing storage units H 640 (25 1/4") D 495 (19 1/2") - with metal base

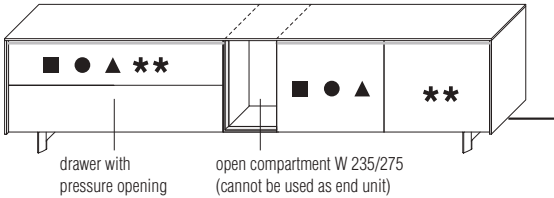

drawer with pressure opening

open compartment W 235/275 (cannot be used as end unit)

- ③ Floor standing sideboard H 630 (24 3/4") D 495 (19 1/2") - with plinth

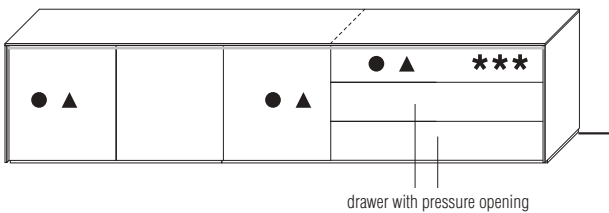

drawer with pressure opening

- \*\*\* Module with open compartment and drawers or hinged doors W 940 (37") / 1100 (43 1/4")



drawer with pressure opening

- Floor standing sideboard H 760 (29 7/8") D 495 (19 1/2") - with metal base

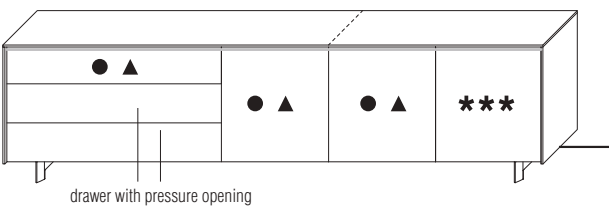

drawer with pressure opening

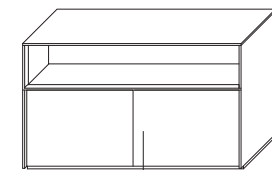

doors with pressure opening

#### DATASHEET

REGISTERED  
DESIGN

IX.2020

**TYPES / DIMENSIONS**

Molteni & C

7 –  
16

- ④ Floor standing storage units with flush sliding doors H 640/760 (25 1/4" / 29 7/8") W 1900 (74 3/4") / 2220 (87 3/8") D 495 (19 1/2") - with metal base

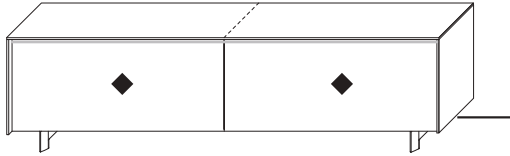

- ⑤ Sideboards with stacked structures and central open compartment D 495 (19 1/2") H various - with plinth

- Sideboards with stacked structures and central open compartment D 495 (19 1/2") H various - with metal base

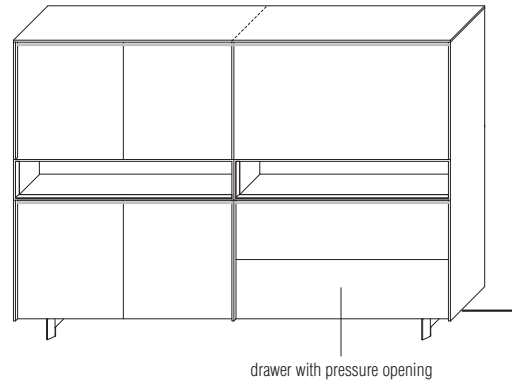
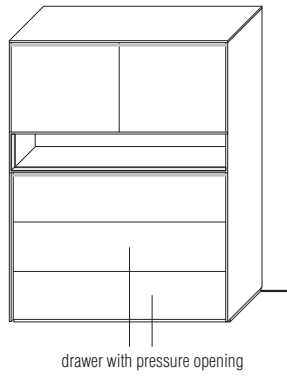

- ⑥ Suspended storage units H 500 (19 3/4") D 385 (15 1/8")

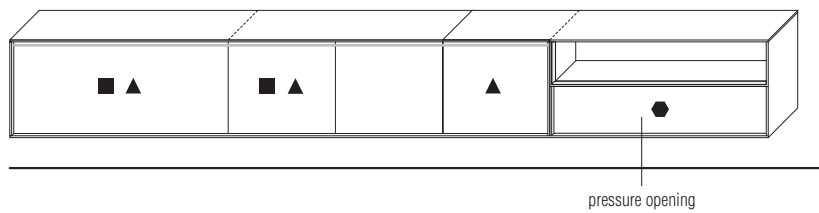

**Legend**

- = Module with open compartment and flap door  
W 940 (37") / 1100 (43 1/4")

- Suspended storage units H 310 (12 1/4") D 385 (15 1/8")

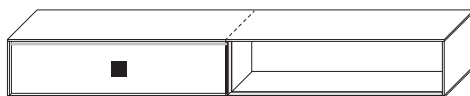

**DATASHEET**

REGISTERED  
DESIGN

IX.2020

## TYPES / DIMENSIONS

- ⑦ Support shelf H 175 (6 7/8") TH 50 (2") W 1480/1830/2220/2560/2770 (58 1/4" / 72" / 87 3/8" / 100 3/4" / 109" ) D 521 (20 1/2")



Molteni & C

- ⑧ Shelves with back H 308/616/924 (12 1/8" / 24 1/4" / 36 3/8" ) D 278 (11") W from 950 to 2770 (to the centimetre)

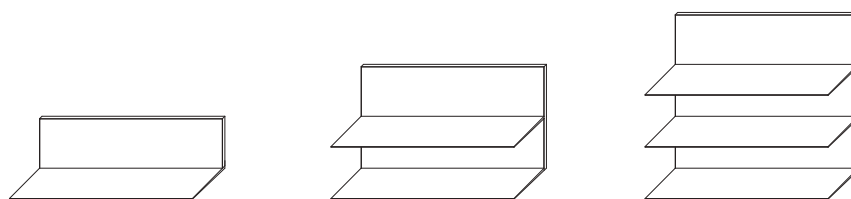

8—  
16

- ⑨ Grado° Bookshelf W 1100 (43 1/4") H 333 (13 1/8") D 314 (12 3/8")

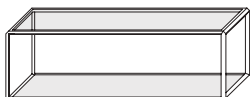

- ⑩ Hanging display cabinet H 1233 (48 1/2") W 470 (18 1/2") D 278 (11")

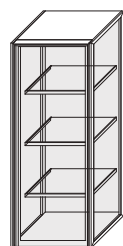

- ⑪ Hi-Tech Bench H 320 (12 5/8") D 600 (23 5/8")

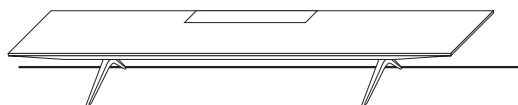

## DATASHEET

REGISTERED  
DESIGN

IX.2020



## MODULARITY

### Modularity of base/storage unit structures

Pass-Word base and storage unit structures, except for flush sliding models, can be used alone or set next to one another as shown in the diagram.

**The upper and lower covering is complete and covers a up to a width of 3000 mm.**

**Compositions with metal base can have a maximum length of 4420 mm.**

**In sizes from 2370 to 3320, the metal base has a central foot.**

**In sizes from 3390 to 4420, the metal base has two central feet.**

**No reductions of any kind are possible.**

**The cabinets are stackable only in the solutions shown on page 137 of the price list.**

Molteni & C

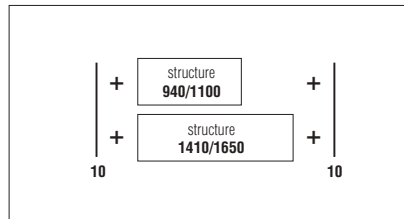

The W 470/550 structure can be set next to the W 1410/1650 structure (ex. **A**) or next to a module with an open compartment (ex. **B**) (ex. **C**).

9—  
16

Example A

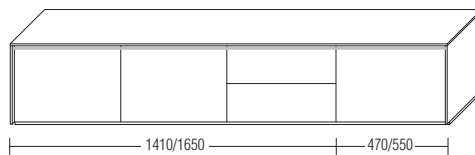

Example B

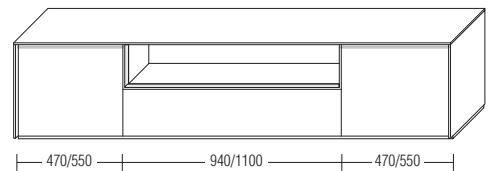

Example C

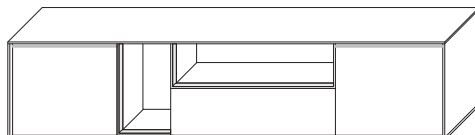

**The structures with W 470/550 can never be used alone or set together with other identical structures. They must only be set together with W 1410/1650 modules or modules with open compartment.**

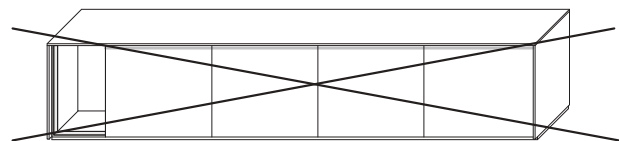
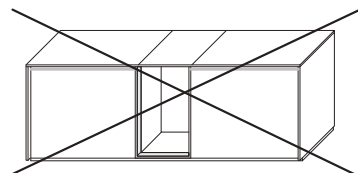
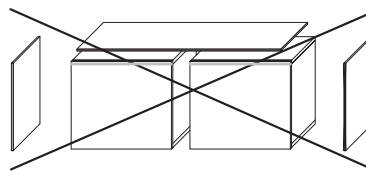
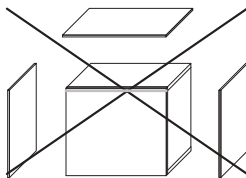

**The W 235/275 open compartment can never be positioned outside of the composition.**

DATASHEET

REGISTERED  
DESIGN

IX.2020

## TOP - JOINING METHOD

For worktops longer than 3000 mm, is it possible to make the joint as shown in the following examples.

**In wood-finish compositions, the joint in the worktops will be assessed by the Molteni Technical Office in relation to the composition of the front piece.**

### GS

The covering is jointed in correspondence with the joints in the structures

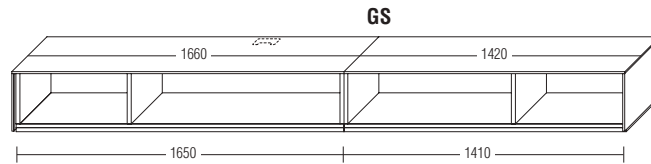

### GCM

Covering joint at the centre of the unit (obtaining 2 pieces of the same size) - Example A

The central joint can only be made at the centre of W 940/1100 compartments

**In wood-finish compositions, the joint in the worktops will be assessed by the Molteni Technical Office in relation to the composition of the front piece.**

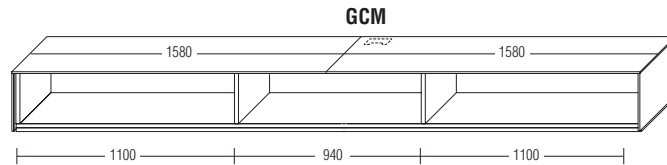

Example A

### GCM

The covering is jointed at the halfway point of the central element W 940/1100 for non symmetrical compositions (we obtain 2 pieces that have almost the same measurements, as close as possible) - Example B

**In wood-finish compositions, the joint in the worktops will be assessed by the Molteni Technical Office in relation to the composition of the front piece.**

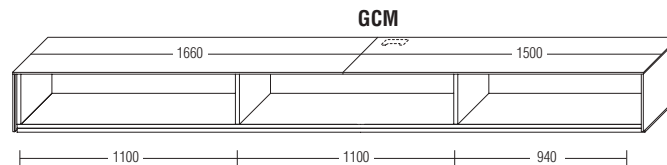

Example B

## WEIGHT LIMITS

### Suspended storage units D 385 (15 1/8") - H finished 310/500 (12 1/4" / 19 5/8")

Suspended storage units are made with structures in 2 heights: 290 (11 3/8") and 480 (18 7/8"). To complete the composition, it is obligatory to use the upper, lower and side coverings. It is possible to create open compartments with the specific element.

No reductions of any kind are possible.

The W 470 (18 1/2") / (550 (21 5/8")) structures can **never** be used alone or set together with other identical structures. They must only be set together with W 1410 (55 1/2") / 1650 (65") modules or modules with open compartments.

In wood-finish compositions, the joint in the worktops will be assessed by the Molteni Technical Office in relation to the composition of the front piece.

# Molteni & C

11—  
16

### Structure for suspended storage units H 290 (11 3/8") / 480 (18 7/8")

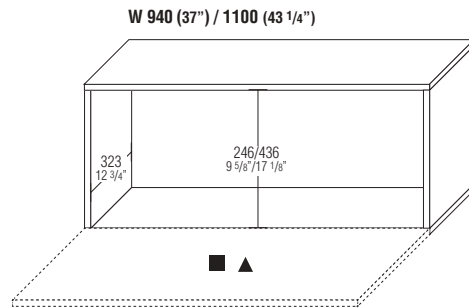

### Max. load uniformly distributed

Kg 25

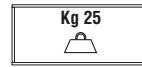

Kg 25

### Legend

■ = Flap door

▲ = Hinged door

### W 1410 (55 1/2") / 1650 (65") (only H 480) - SX version

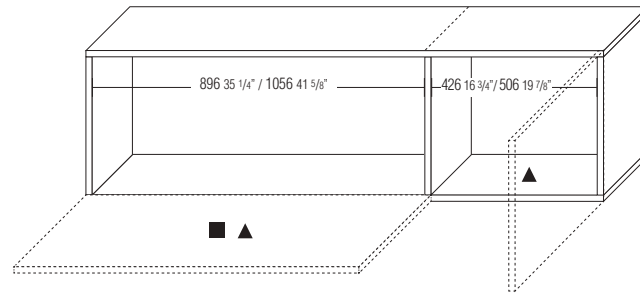

### Suspended storage units H 480 (18 7/8") with open compartment and flap doors

W 940 (37") / 1100 (43 1/4")

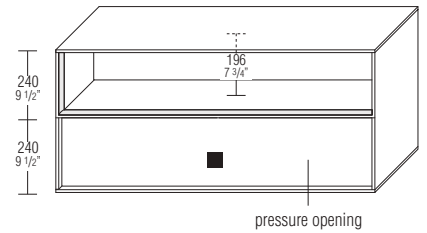

W 940 (37") / 1100 (43 1/4")

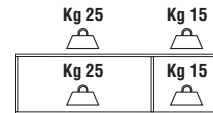
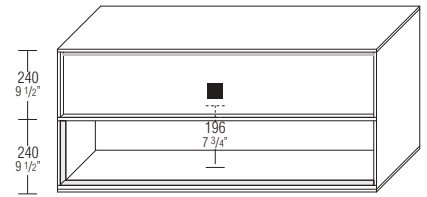

For the 1410 (55 1/2") / 1650 (65") module, when ordering, it is necessary to specify the right or left side version (determined by the 940 - 37" / 1100 - 43 1/4" compartment).

In the left version, the hinged door of the 470 (18 1/2") / 550 (21 5/8") compartment is always on the right, and vice versa.

### Open compartments W 235 (9 1/4") / 275 (10 7/8")

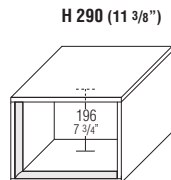

### H 480 (18 7/8")

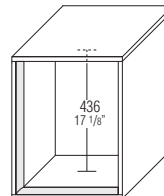

### DATASHEET

REGISTERED  
DESIGN

IX.2020

**Floor-standing sideboards D 495 (19 1/2") made with stacked structures**

The stacked structures are always made with a central open compartment H 240 (9 1/2").  
The lower and upper structures can be made using elements H 480 (18 7/8") and/or H 600 (23 5/8") always closed with doors or drawers.  
It is possible to make compositions with one or more W 940 (37") / 1100 (43 1/4") modules set adjacent, always aligning the open compartments in the middle.  
The stacked structures can be set on a plinth or metal base.

**Stacking structures different from those indicated is not possible.**

**Example of composition diagram**

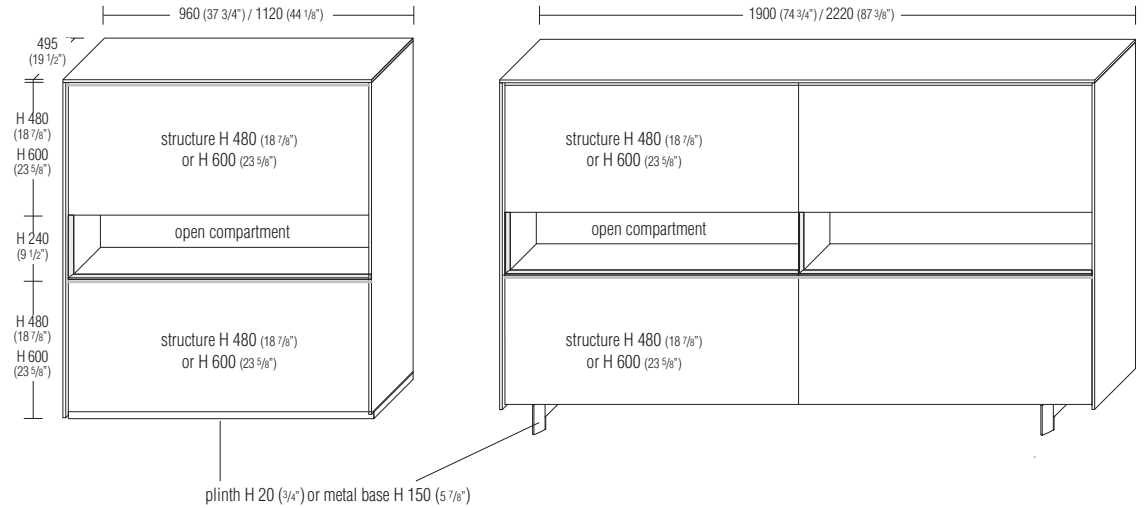

**Legend**

- = Flap door
- ▲ = Hinged door
- = Drawers

**Height of modules**

Finished heights with plinth and covering

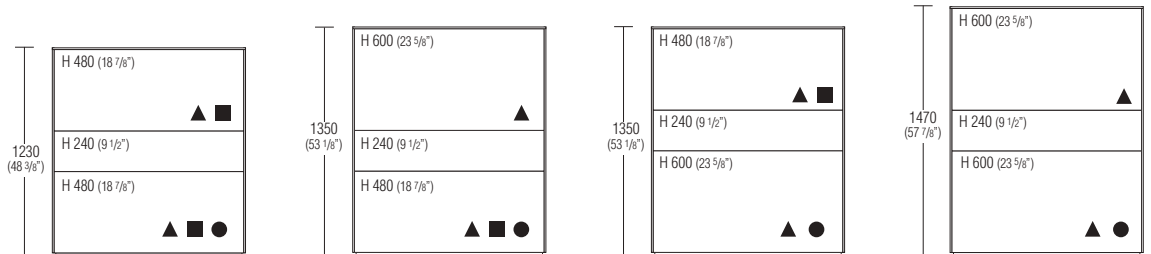

**Height of modules**

Finished heights with metal base and covering

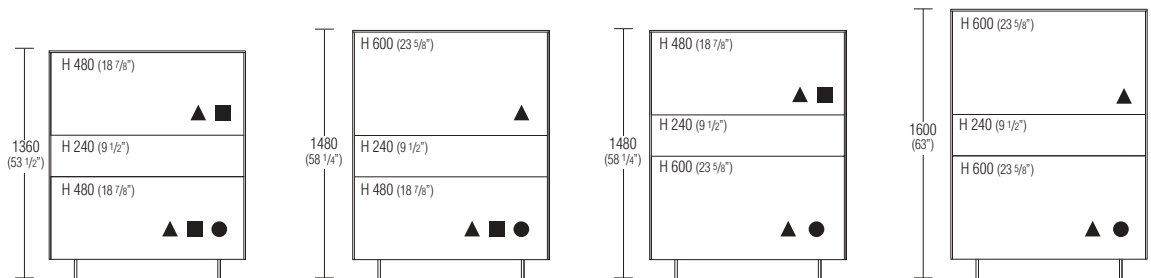

**DATASHEET**

REGISTERED  
DESIGN

IX.2020

### SHELVES WITH BACK

Shelves with back are available in 4 versions:

- 1 shelf H 308 12 1/8"
- 1 shelf H 616 24 1/4"
- 2 shelves H 616 24 1/4"
- 3 shelves H 924 36 3/8"

Wall fastening (with adjustments) takes place using special brackets hidden behind the back panels.

Plates must be anchored to the wall using state-of-the-art procedures on walls in masonry (solid wall or hollow brick).

The dealer is responsible for help in choosing the right tools to safely perform every type of operation and guarantee safety and capacity (**Kg 15 per linear metre, uniformly distributed**).

We recommend a very scrupulous evaluation of the structural conditions of the wall prior to ordering and mounting the product.

Molteni&C is not responsible for mounting procedures that do not comply with the instructions above.

### Shelf finishes

- pewter colour
- copper
- zinc

### Back finishes

- matt lacquer in Molteni range colours
- glossy lacquer in Molteni range colours
- wood

**Shelves with back panel can be custom made in width (min. 950 / max. 2770), they cannot be reduced in depth and the height of the modules cannot be changed.**

Each single shelf can be outfitted with a LED lighting bar.

The shelf/shelves block, in the various sizes, is always completed with a special top and side closing profile in the same finish as the shelves.

For the best installation result, we suggest providing electrical connections in the part behind the back panels as shown in the drawing below.

The top back panel is provided with a compartment that can house power supply units, connector, and remote control kit.

side section

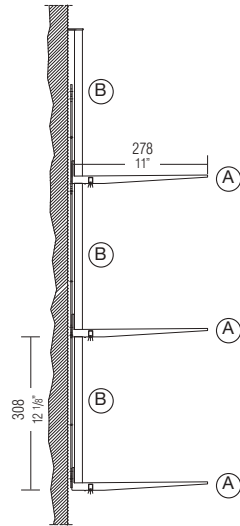

front view

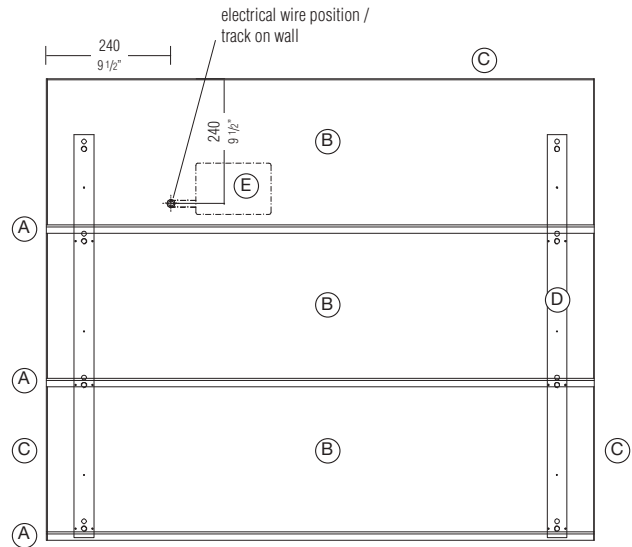

- (A) Shelf
- (B) Back panel
- (C) Side (dx-right, sx-left) and upper closing profile
- (D) Wall fastening bracket
- (E) Compartment containing electrical components

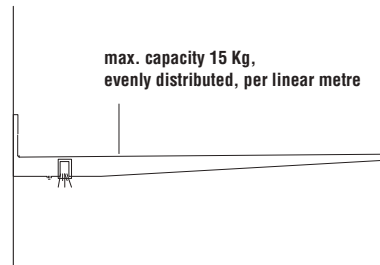

### DATASHEET

REGISTERED  
DESIGN

IX.2020

### SUPPORT SHELVES

Support shelves are mounted on the wall with special plates. Plates must be anchored to the wall using state-of-the-art procedures on walls in masonry (solid wall or hollow brick). The dealer is responsible for help in choosing the right tools to safely perform every type of operation and guarantee safety and capacity (**Kg 30 per linear metre, uniformly distributed**).

We recommend a very scrupulous evaluation of the structural conditions of the wall prior to ordering and mounting the product.

Molteni&C is not responsible for mounting procedures that do not comply with the instructions above.

On request, a kit with chemical anchors is available, as indicated on the following page (minimum wall thickness 100 mm).

The support shelf is completed with a wall panel and, on the top, a rise with wire passage in predefined positions (see diagram).

**The wire passage is included in the price and if a support shelf without wire passage is requested, no increase will be considered.**

For sizes 2560 and 2770 mm, is it possible, on request, to provide multiple wire passages in the predefined positions, considering a surcharge for each.

The rise can be fitted with an LED lighting bar, including power supply unit, to be connected to a controlled switch or to the (optional) remote control kit.

The lower part of the support shelf can receive conduit for electrical wires.

**The conduit is mandatory in the presence of LED lighting bars and wire passages.**

# Molteni&C

14 –  
16

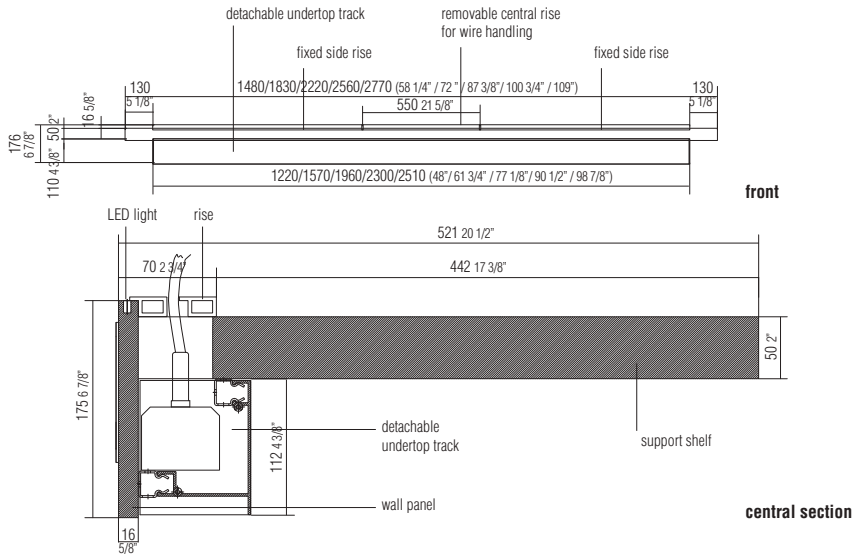

#### Wire passage position on the support shelf

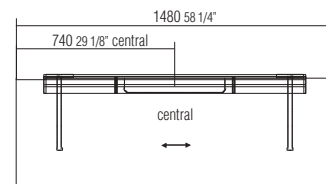
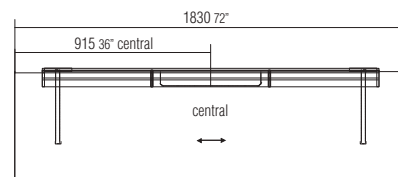
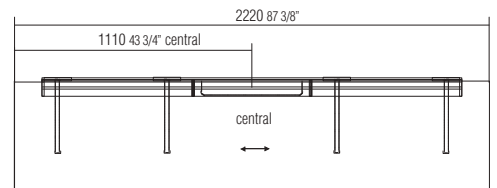
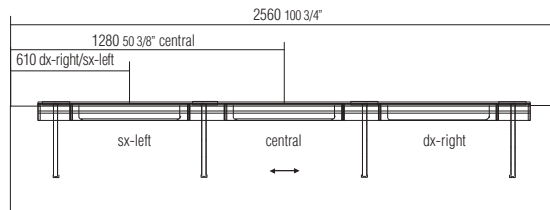
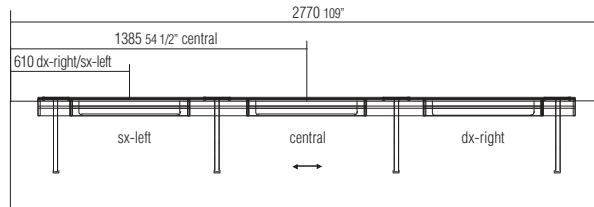

### DATASHEET

REGISTERED  
DESIGN

IX.2020

PASS-WORD  
EVOLUTION –  
DANTE  
BONUCELLI  
2014 / 2019

### HANGING DISPLAY CABINET

The hanging display cabinet is always made with:  
- pressure opening  
- no. 3 internal shelves in transparent glass

**Overall load capacity, evenly distributed on the internal shelves, Kg 8.**

**No reductions of any kind are possible.**

**The cabinet shelves can be equipped with LED lighting (3000° K).  
A single system for LED lighting on all shelves.**

### Wood / metal part finishes

matt lacquer pewter colour / pewter colour  
matt lacquer copper / copper  
matt lacquer zinc / zinc

### Door and side glass finishes

transparent  
transparent stopsol

Molteni & C

15  
16

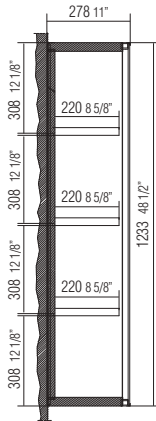

lateral section

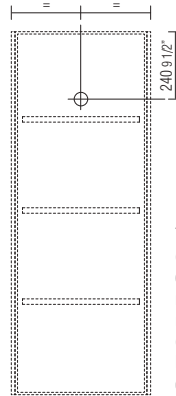

The power cord must come out of the wall in correspondence with each wall mounted module and it must be prepared for use with a remote controlled switch or a radio control kit. Electrical connections must be carried out by qualified personnel.

### DATASHEET

REGISTERED  
DESIGN

IX.2020

[moltenigroup.com](http://moltenigroup.com)

Dimensions in millimeters and inches. The right to discontinue and make changes is reserved. This information is based on the latest product information available at the time of printing.

**HI-TECH BENCH**

The Hi-Tech bench comes in two different models:  
 - D 600 (23 5/8") without wire passage compartment  
 - D 600 (23 5/8") with wire passage compartment  
 The bench structure (lower part) is always in silver lacquer.

**Shelves finish**  
 matt lacquer colours  
 graphite oak  
 walnut  
 eucalyptus

**Feet finish**  
 black chrome  
 pewter colour  
 zinc

**No reductions possible.**

**Hi-Tech Bench - D 600 (23 5/8") without wire passage compartment**

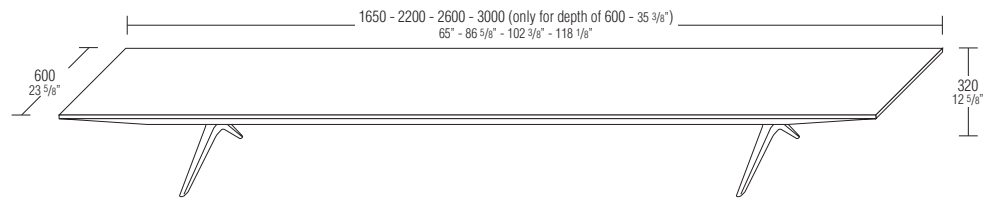

**Hi-Tech Bench - D 600 (23 5/8") with wire passage compartment**

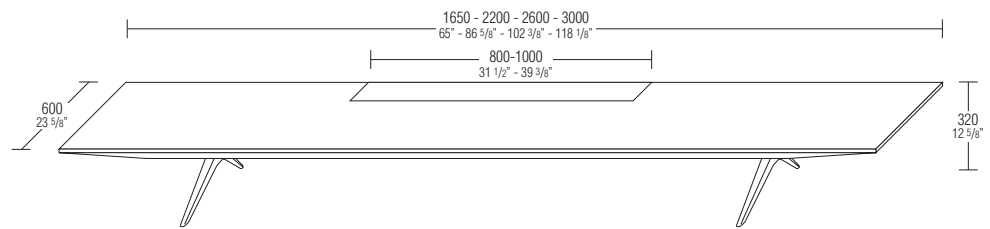

The wire passage compartment of 800 (31 1/2") is present in benches W 1650 (65"), and the 1000 (39 3/8") wire passage compartment is on benches W 2200 (86 5/8"), 2600 (102 3/8") and 3000 (118 1/8").

**Modifications are not possible.**

**Rear view**

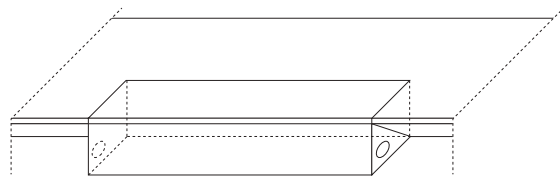

**Lateral section**

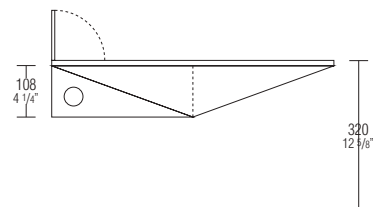

**DATASHEET**

REGISTERED  
DESIGN

IX.2020